

EKO

VIDAA

32" HD SMART TV

K32HV



INSTRUCTION MANUAL

Please read this manual carefully before using, and keep it for future reference.

CONTENTS

General Safety	4
Technical schedule	12
Specification	13
Installation	14
Controls and Connections	16
Remote Control	18
Initial Setup	21
VIDAA TV - Home Screen	26
Setting	
Picture Setting	27
Sound Setting	29
Network Setting	31
Channel Setting	33
Accessibility Setting	36
System Setting	37
Support Setting	40
Multi-Screen	42
USB Device	43
FAQs	44
WEEE	45

GENERAL SAFETY INSTRUCTIONS

Read this instruction manual carefully as it contains important information on the safety, use and maintenance of the appliance. Keep the manual for future reference.

1. Disconnect the plug from the wall socket in case of a long period of disuse. Disconnect the plug and antenna cable even in severe thunderstorms.
2. Do not pull the cable to pull the plug out of the socket.
3. Do not rest heavy objects on the cables.
4. Do not bend or knot the cables.
5. The TV screen is made of a fragile material, therefore, it should not be subjected to impact or pressure to avoid damage. If it is damaged, remove the plug from the socket and contact a service center. If liquid comes out of the panel, be careful and do not let it come into contact with your eyes and mouth, contact a doctor if necessary.
6. Switch off and unplug from the mains before cleaning and maintenance. For cleaning, use only a clean dry cloth. Do not use aggressive detergents such as thinners, alcohol, petrol.
7. Place the device on a stable surface that can withstand its weight. If you are using a mobile, it must be strong and large enough to prevent the TV from protruding beyond edges of the cabinet. If it is fixed to the wall, follow the instructions for correct fixing to avoid danger. Do not place the TV in high positions (furniture, shelves, shelves) unless they are properly fixed to the wall. Do not place any textile or similar product between the TV and the furniture. It is necessary to inform children about the dangers so as to prevent them from climbing on the furniture to reach the TV and its accessories.
8. Leave adequate space on the sides of the TV to ensure proper ventilation.
9. Do not expose the TV to direct sunlight, heat sources or naked flame sources (candles).
10. No objects containing liquids, such as vases, should be placed on the TV. Avoid exposure to drops and splashes of water.
11. Connect only to a mains socket that complies with the regulations in force and in accordance with the rating plate data of the TV. The mains socket must be close and easily accessible to disconnect the TV in case of danger. If the TV does not have a specific shutdown switch, to turn off the TV, disconnect the mains plug.
12. Do not insert objects of any kind into the slots of the TV due to the danger of electric shock. If the TV does not have a specific shutdown switch, to turn off the TV, disconnect the mains plug.
13. Do not insert objects of any kind into the slots of the TV due to the danger of electric shock.
14. Read this manual carefully before using the TV.
15. Keep this manual, the complete warranty card, receipt, and product packaging. The safety precautions instructions reduce the risk of fire, electric shock and injury when followed correctly. Please follow all instructions and take note of all warnings.

GENERAL SAFETY INSTRUCTIONS (Cont.)

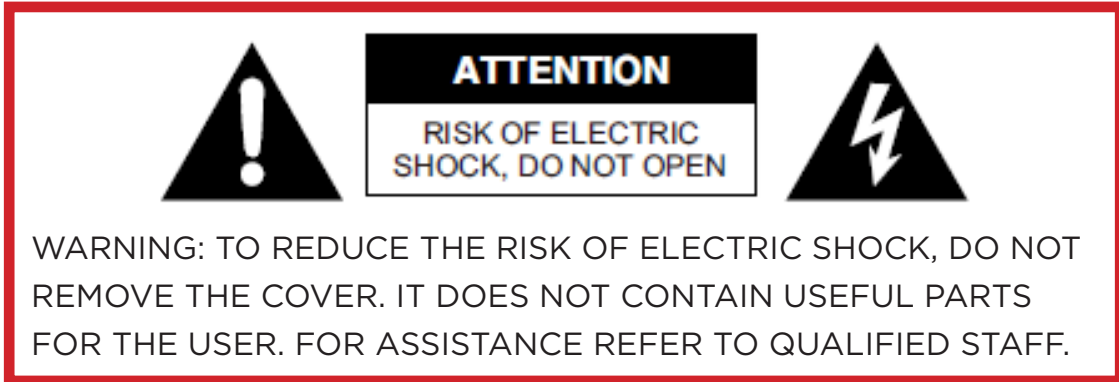

ATTENTION
RISK OF ELECTRIC SHOCK, DO NOT OPEN

WARNING: TO REDUCE THE RISK OF ELECTRIC SHOCK, DO NOT REMOVE THE COVER. IT DOES NOT CONTAIN USEFUL PARTS FOR THE USER. FOR ASSISTANCE REFER TO QUALIFIED STAFF.

The cover (or back) of the unit should not be removed to prevent risk of electric shock. This unit must be serviced by a qualified service personnel only.



The lightning flash with symbol within the triangle is intended to warn you of a non-insulated dangerous voltage in the product's enclosure that could be of sufficient magnitude to generate a risk of electric shock to persons.



The exclamation point within the triangle is intended to warn you to the presence of important operating and maintenance instructions in the documents included with the product.



To avoid possible hearing damage, limit the listening time to high volumes.

GENERAL SAFETY INSTRUCTIONS (Cont.)

IMPORTANT INFORMATION

1. Use furniture or stands recommended by the manufacturer.
2. The product must be installed on a surface that correctly supports its weight.
3. Make sure that the product rests completely on the surface on which it is installed.
4. Do not place the product on a tall cabinet without fixing neither the cabinet nor the product stably.
5. This will prevent the TV from falling.
6. Do not place the product on top of conductive or flammable fabrics or other materials.
7. Make sure that children do not climb onto the furniture or support where the TV is installed, with the intention of getting close to it, thus avoiding any risk of falling of the support or product;
any operation on the TV must be carried out by an adult.

IMPORTANT INFORMATION

1. Do not expose this appliance to rain or moisture as it may cause a fire or an electric shock hazard.
2. Do not tamper with or modify the product in any way.
3. Use only accessories described and recommended by the manufacturer.
4. Please do not expose the product to direct contact with water.
5. Do not place any objects on top of the product, including liquid containers such as glasses.
6. Be careful when replacing the remote controller battery; incorrect installation can lead to explosion risks. Replace with the same or equivalent type of battery.

GENERAL SAFETY INSTRUCTIONS (Cont.)

Installation

16. **Please follow instruction when installing this product in accordance with the instruction manual. This product must be placed on a sufficiently stable surface; incorrect installation is potentially dangerous as the TV could fall and cause injury. Be extremely careful around children.**
17. Before installing the product, make sure that the output voltage corresponds to that indicated on the rear label of the TV where the electrical specifications are shown.
18. Do not use a damaged power cord or plug, or a power outlet with a loose connection. This could cause an electric shock.
19. Do not connect multiple devices to the same socket. This could cause the outlet to overheat and cause a fire. Make sure that the socket is easily accessible when operating the TV.
20. Do not bend, wrap or twist the power cord excessively.
21. Do not let anything rest on the power cord and antenna cable. This could cause a fire or electric shock.
22. Do not use the power cord near appliances that produce heat such as radiators, stoves, or irons. Excessive heat could melt the insulation and expose live wires, causing fire or electric shock.
23. Unplug this TV during lightning storms or when unused for long periods of time. Otherwise, it could result in fire or electric shock.
24. Do not block the ventilation openings of the product with items such as newspapers, tablecloths, curtains. Do not insert objects into the slots available on the sides and rear of the TV. This could cause the temperature inside the TV to rise and cause a fire.
25. If you notice any unusual smells or smoke coming from the TV, unplug the power cord from the outlet immediately and contact the service center. Otherwise, it could result in fire or electric shock.
26. When not using the TV for long periods of time or when it needs to be moved, be sure to unplug the power cord from the wall outlet.
27. The TV should be cleaned periodically. Otherwise, the dust could accumulate over time and cause the temperature inside the TV to increase and / or the insulation of the connections to deteriorate, which in turn could cause an electrical fire.
28. The product is not intended for use by people (including children) with reduced physical, sensory or mental abilities, or small children of any age, unless supervised by an adult responsible for their safety.
29. The remote controller batteries should only be removed by an adult, making sure to keep them out of the reach of infants and children. Seek immediate medical attention if a child has swallowed a battery.

GENERAL SAFETY INSTRUCTIONS (Cont.)

30. Batteries should not be exposed to direct sunlight or heat.
31. To clean the TV, do not use chemicals, detergents, or wet cloths, be sure to use a dry cloth to clean it of marks or dust and only after unplugging the product from the power outlet.
32. Contact a qualified service center for any repair or other service required.

WARNING!

1. We strongly recommend that you lock the TV to the stand on which it is installed.
2. In this way, accidents caused by the furniture or TV overturning can be prevented.
3. To avoid any risk of serious injury, we strongly recommend that this product be permanently attached to the wall or another suitable surface.
4. Fasteners are not included as surfaces made of different materials require different fixtures. Please contact qualified personnel.
5. If a TV is not placed stably enough, it can be potentially dangerous due to accidental fall. Many injuries, particularly for children, can be avoided by taking simple precautions such as:
6. Use furniture or stands recommended by the manufacturer.
7. The product must be installed on a stand that can support the weight and size of the TV.
8. Make sure that the product rests completely on the surface on which it is installed.
9. Teaching children about the dangers that can arise from climbing on furniture with the aim of reaching.

Be sure to position the product according to the following considerations:

33. Prefer dry surfaces in well ventilated areas.
34. Do not expose to sunlight and other heat sources.
35. Do not expose to contact with water or other liquids.
36. Protect from dust and pollutants.
37. Do not install the TV on furniture with limited space, such as bookcases.
38. Do not install the TV near heat sources such as radiators, stoves or other appliances that produce heat.
39. Do not place containers with liquids next to the TV; if the liquid were to fall and penetrate inside the casing, it could cause short circuits, fires or electric shocks.

GENERAL SAFETY INSTRUCTIONS (Cont.)

40. Do not place small metal objects on top of the unit; if such objects penetrate the TV casing, this could cause short circuits, fire or electric shock.
41. Do not use or store flammable or combustible materials near the unit. This could cause fire or explosion. Do not place open flames, such as lighted candles, cigarettes, or incense sticks on top of the TV.
42. It is advisable that the antenna is installed away from the power outlet; Please contact a professional antennatechnician to install the antenna, to avoid incorrect installation which could cause fire, electric shock, or serious injury.
43. Install the unit at a reasonable distance from the wall to ensure sufficient ventilation.
44. Connect the power supply of your TV to an easily accessible and easy to disconnect socket.
45. Do not use this apparatus near water. For example, do not use near a laundry tub, in a wet cellar, near a swimming pool or the like.
46. Clean the appliance only with dry cloths.
47. Do not block the ventilation openings. Install in accordance with the manufacturer's instructions. The slots and openings on the back or bottom are for ventilation, to ensure reliable operation of the TV and to protect it from overheating. Do not block or cover these openings. Do not block the openings by placing the TV on a bed, a sofa or similar surfaces
48. Do not install this unit near heat sources such as radiators, heating vents, stoves or other apparatus (including amplifiers) that produce heat.
49. Do not alter the safety purpose of the polarized or grounding-type plug. A polarized plug has two blades with one wider than the other. A grounding plug has two blades and a third grounding prong. The largest lamella or the third pole perform a protective function. If the provided plug does not fit into your outlet, consult an electrician for replacement of the obsolete outlet.
50. Protect the power cord from being walked on or pinched particularly at plugs, convenience receptacles, and the point where the cord exits the apparatus.
51. Use only accessories specified by the manufacturer.
52. Use only with the cart, stand, tripod, bracket, or table specified by the manufacturer, or sold with the apparatus. When using a cart, be careful when moving the cart and the appliance together to avoid injury from overturning. The TV / cart assembly must be moved with care. Quick stops, excessive force, and uneven surfaces could cause the cart and TV to tip over.
53. Unplug this apparatus from the power supply during lightning storms or when it will not be used for a long time. For added protection of the TV receiver during a lightning storm or when it is not used for an extended period, unplug it from the wall outlet and disconnect the antenna or cables. This will prevent damage to the TV caused by lightning or power surges.

GENERAL SAFETY INSTRUCTIONS (Cont.)

54. Have repairs carried out by qualified service personnel only. Maintenance is required if the appliance has been damaged in any way, such as damage to the power cord or plug, if liquid has been spilled or objects have fallen into the appliance, appliance has been exposed to rain or moisture, if it does not operate normally or has been dropped.

55. This TV should only be operated with the type of power source indicated on the rating plate. If you are unsure of the type of power supply in your home, consult your dealer or local power supplier. For battery power supply of the TV remote control, refer to the operating instructions.

56. The television should not be exposed to dripping or splashing water. Do not place objects filled with liquids, such as vases, on the TV.

57. Never push objects of any kind into the TV through openings as they may touch dangerous voltage points or other electrical components which could result in fire or electric shock. Do not spill liquids of any kind on the TV.

58. Unplug the TV from the wall socket before cleaning. Do not use liquid or aggressive detergents. Use a damp cloth for cleaning.

59. Do not place the television near or on top of radiators or other heat sources. Do not place the TV in recessed places such as bookcases or shelves unless adequate ventilation is provided or the manufacturer's instructions are followed.

60. Do not place the TV on an unstable cart, stand, tripod, bracket or table. The TV may fall, causing serious injury or damage to the set.

61. Do not try to repair the TV yourself. as opening or removing covers may expose the user to dangerous voltage or other hazards. Have repairs carried out by qualified service personnel only.

62. **WARNING:** To avoid injury, the appliance must be securely fastened to the floor or wall according to the installation instructions.



The terms HDMI, HDMI High-Definition Multimedia Interface, and the HDMI Logo are trademarks or registered trademarks of HDMI Licensing Administrator, Inc.



GENERAL SAFETY INSTRUCTIONS (Cont.)

TREATMENT AND DISPOSAL OF BATTERIES

1. ATTENTION: incorrect replacement of the batteries or the use of batteries of different types non-equivalent can cause explosions.
2. The battery should not be exposed to excessive heat such as that from the sun, fire or similar sources.
3. Do not mix different types of batteries, or new batteries with old ones.
4. The battery must be positioned according to the correct polarity.
5. If the battery is low it must be removed from the product.
6. The battery must be disposed of safely. To protect the environment, always use the appropriate collection containers (consult your dealer).
7. Keep batteries away from children and pets. Only adults are allowed to take care of the batteries.
8. Never throw batteries into fire or expose them to flames or other heat sources.
9. Follow the safety and use instructions for the battery.

CLEANING AND MAINTENANCE

1. Unplug the unit from the electrical outlet before cleaning.
2. To remove dust, wipe gently with a soft, lint-free cloth.
3. If necessary, use a slightly damp cloth.
4. Clean the plug with a dry cloth at regular intervals.
5. CAUTION: Moisture and dust can lead to fire or electric shock.
6. Be careful not to use liquids or detergents that can get inside the TV. (Liquid inside the TV may cause product failure, fire or electric shock.)
7. Do not clean with abrasive cloths and aggressive products such as insect repellents, solvents, thinners or other substances that may deteriorate the surface and finish of the TV cabinet.

Dear Customer

Herewith the manufacturer **AYONZ CENTRAL LTD** declares that this device complies with the 2014/53 / EU Directives.

The full text of the EU declaration of conformity is available at the following internet address: www.eko-entertainment.it

TECHNICAL SCHEDULE

Information	Value and precision			Unit
Supplier's name or trade mark	EKO			--
Supplier's model identifier	K32HV			--
Energy efficiency class for standard Dynamic Range (SDR)	E			--
On mode power demand for Standard Dynamic Range (SDR)	26			W
Energy efficiency class (HDR)	-			--
On mode power demand in High Dynamic Range (HDR) mode	-			W
Off mode, power demand	0			W
Standby mode, power demand	≤0.5			W
Networked Standby mode, power demand	≤ 2			W
Electronic display category	television			--
Size ratio	16	:	9	integer
Screen resolution (pixels)	1366	x	768	pixels
Screen diagonal	80			cm
Screen diagonal	32			inches
Visible screen area	2736.6			cm ²
Panel technology used	LED LCD			--
Automatic Brightness Control (ABC) available	NO			--
Voice recognition sensor available	NO			--
Room presence sensor available	NO			--
Image refresh frequency rate	60			Hz
Minimum guaranteed availability of software and firmware updates (until):	08/30/2025			--
Minimum guaranteed availability of spare parts (until):	08/30/2025			--
Minimum guaranteed product support (until):	08/30/2025			--
Power supply type:	Internal			--

SPECIFICATIONS

Display Device	32" HD Smart TV
Resolution	1366 x 768
Display Colours	16.7 Million
Contrast ratio:	3500 : 1
Aspect Ratio	16 : 9
WIFI Working Frequency	2.4GHz
Maximum Transmission Power of WIFI	802.11 b - 16.5±2 dBm at 11Mbps 802.11 g - 14±2 dBm at 54Mbps 802.11 n - 13±2dBm at MCS7
Software of Version	20230730_174850
Input / Output	Tuner: DVB-T2 H.265 HEVC MAIN 10, DVB-S2 HDMI x3, USB x2, OPTICAL Out x1, RF IN x2, RJ45 x1, AV IN x1, EARPHONE x1, CI+ x1
Multimedia Playback Format under USB Mode	Movie: : MPEG, MP4, MKV, AVI, FLV, TS
	Music: WAV, MP3, AAC, PCM, AC3, FLAC
	Photo: JPEG, PNG, BMP, GIF
Power Source	100-240V ~ 50/60Hz
Power Consumption	60 W
Dimensions	With stand: 719 x 191 x 471 mm (w x d x h)
	Without stand: 719 x 90 x 423 mm (w x d x h)
Weight	Net: 3.4 kg
	Gross: 4.9 kg

NOTE: This document is for reference only, the operation interface is subject to the TV software.

INSTALLATION

Install the stand as described below, or if you want to mount it to a wall, please contact a professional installer.

Please ensure the TV is not plugged into the wall socket and furthermore we recommend to get another person to assist in the following task.

Attaching the stand

Step 1

Place a soft cushioned material on top of a flat surface to prevent damaging the screen panel. Then place the TV screen flat on top, with the screen side facing down, as illustrated on the right.

Step 2

Align the stand leg to the installation point, as illustrated below

Step 3

Tighten the screws (supplied) with a screwdriver to affix the stand to the panel, as illustrated on the right.

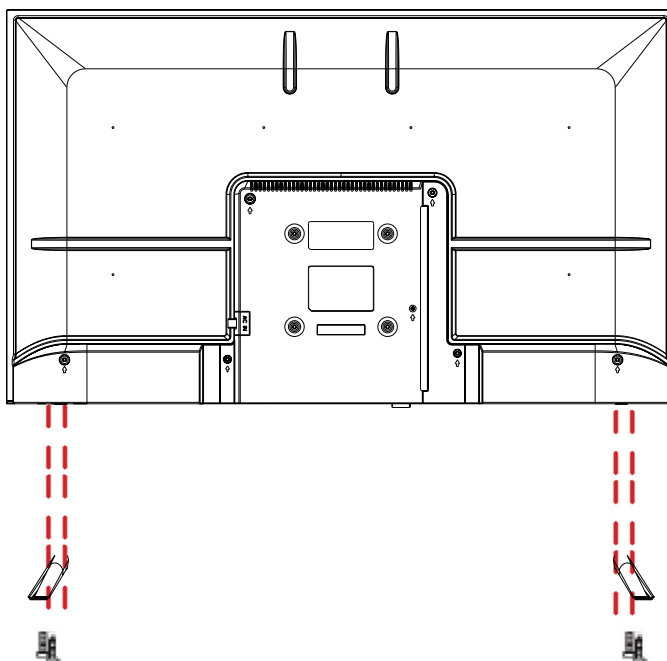

CAUTION!

Do not apply excessive force as this may damage the screw holes.

INSTALLATION (Cont.)

Wall-Mounting Instructions

Please ensure the TV is not plugged into the wall socket and furthermore we recommend to get another person to assist in the following task.

- We recommend you use a professional installer as we assume no liability for any eventual damage to the product or injury to yourself if you mount the TV on your own.

BACK OF TV

VESA PATTERN: 100 x 100mm

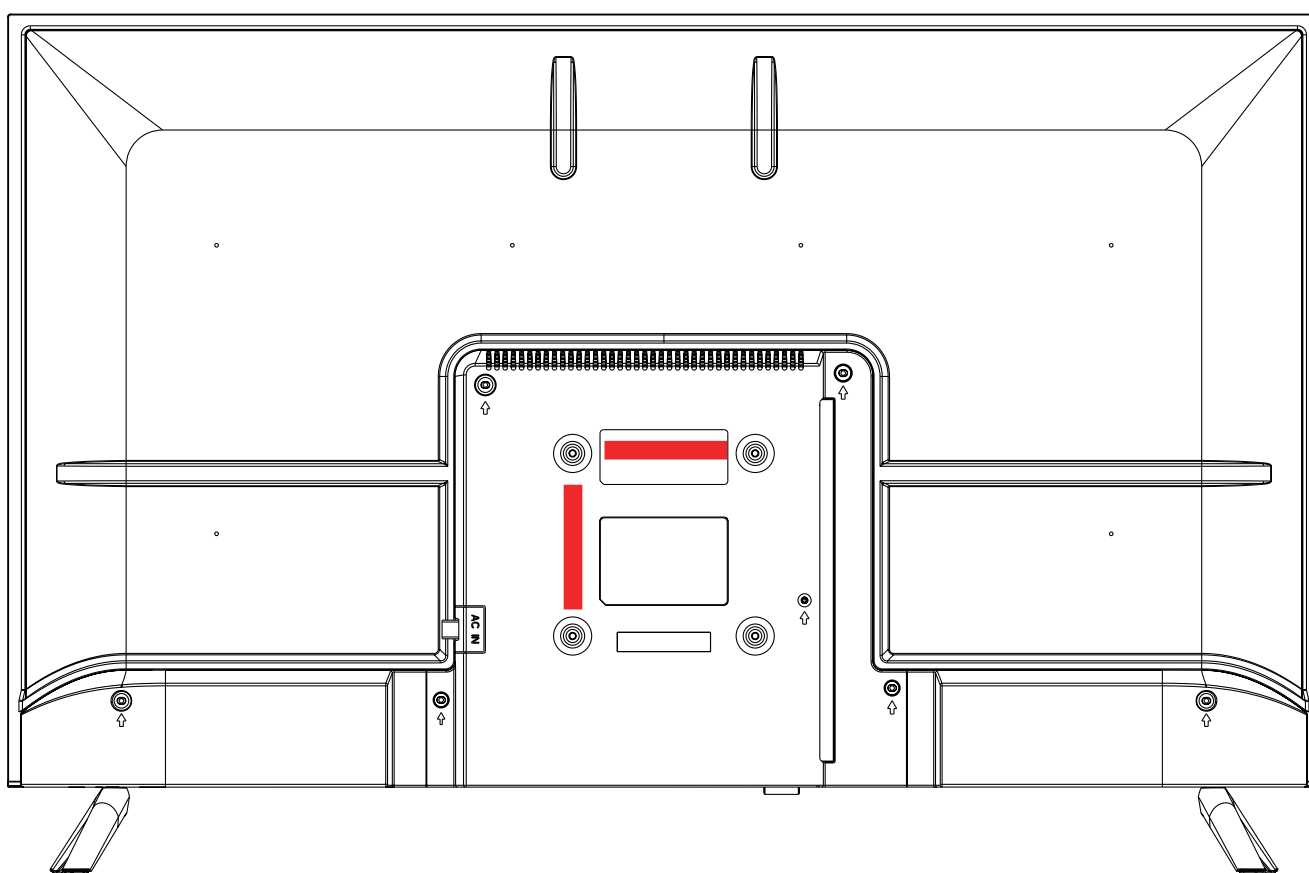

NOTE: If you are wall-mounting the TV, this should be done by a qualified installer.

CONTROLS AND CONNECTIONS

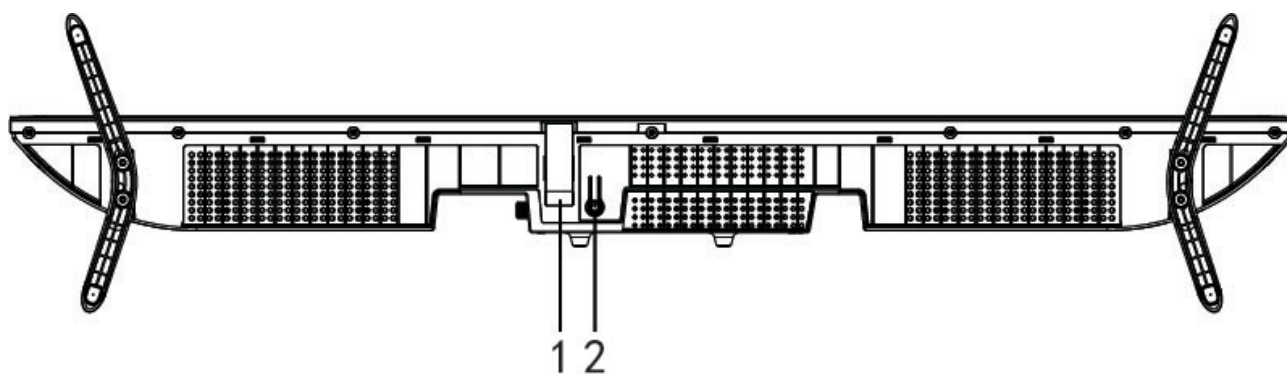

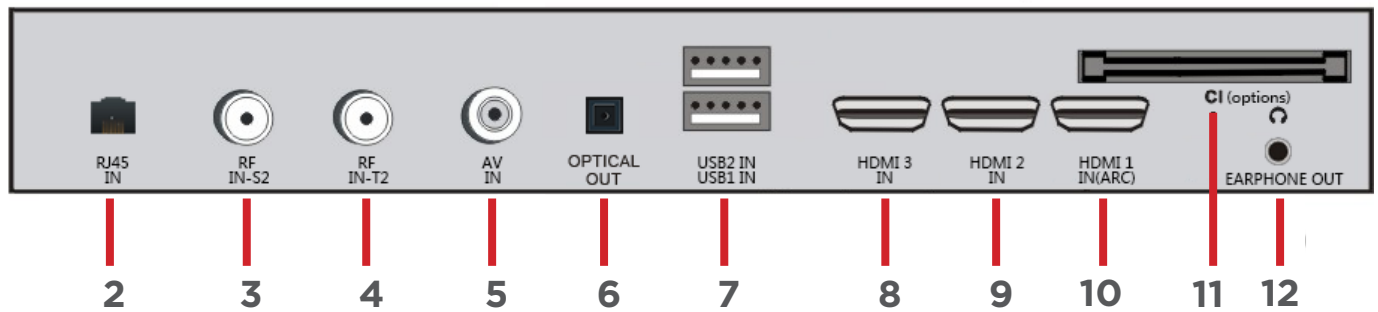
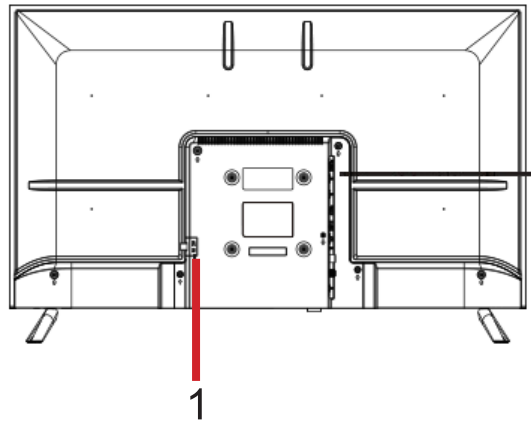

- 1. REMOTE CONTROL SENSOR / POWER INDICATOR:** In standby mode the indicator light will display red color; when switching on the unit the indicator light will no light.
- 2. STANDBY BUTTON:** TO TURN ON/OFF THE TV.

CONTROLS AND CONNECTIONS



1. POWER INPUT
2. ETHERNET INPUT (RJ45)
3. RF1 (S2)
4. RF2 (T2)
5. AV IN
6. OPTICAL
7. USB 1 & 2
8. HDMI 3
9. HDMI 2
10. HDMI 1 / ARC
11. CI+
12. EARPHONE

REMOTE CONTROL

- 1. STANDBY(POWER):** Set the unit in standby mode; press it again to switch it on.
- 2. INPUT:** Select the input source.
- 3. Number buttons (0-9):** Select a TV channel.
- 4. GUIDE:** Launch the Program Guide.
- 5. CH.LIST:** Channel list.
- 6.**  : Corresponds to various colour functions in the menu or teletext.
- 7. MENU:** Display the main menu.
- 8.  :** Press to operate start/pause playing; Move fast forward; Move fast backward.
- 9. DIRECTION:** navigate the on-screen menu.
OK: Select current option that's highlighted.
- 10. Return:** Return to the previous interface or menu.
- 11. EXIT:** Exit the current interface or menu.
- 12. HOME:** Press to enter home page.
- 13. VOL +/-:** Turn the volume up/down.
- 14. CH +/-:** Play the next/previous program.
- 15. MUTE:** Mute the sound.
- 16. SUBTITLE:** Enable/disable subtitles.
- 17. TEXT:** Turn on/off the Teletext.



REMOTE CONTROL (CONT.)

18. INFO: Display the available program information.

19. : Set up APP shortcut key.

20. FREE: Enter to the free video.

21. DEEZER: Enter to the deezer directly.

22. APPS: Open application.



Universal Remote Control Code: 00BF

REMOTE CONTROL (CONT.)

REMOTE CONTROL BATTERY INSTALLATION AND WARNINGS

- Open the battery compartment cover on the back of the remote control
- Insert 2 x 1.5V type AAA batteries placing them according to the correct polarity.
- Open the battery compartment cover on the back of the remote control
- Insert the batteries (check the number of batteries and the type in the remote control compartment) with the correct polarity
- Close the battery compartment cover.
- Batteries once installed should not be exposed to excessive heat such as sunshine, fire or the like.
- Do not use old and new batteries in the remote control.
- Do not use different types of battery.
- If it is not used for a long time, it is recommended to remove the batteries from the remote control.
- Keep batteries away from children and pets.
- Never throw batteries into fire.
- Accidental dropping of the remote control, resulting in breakage, will immediately invalidate the warranty.
- The remote control works effectively when used up to about 5m away from the TV.
- Do not expose the remote controller sensor to strong light

INITIAL SETUP

For the first initial setup, on screen setup wizard will guide you through setting up your TV. Please follow according to onscreen guide to setup your TV correctly.

Use the ▲/▼ buttons to select system language, then press **OK/SELECT** to confirm.

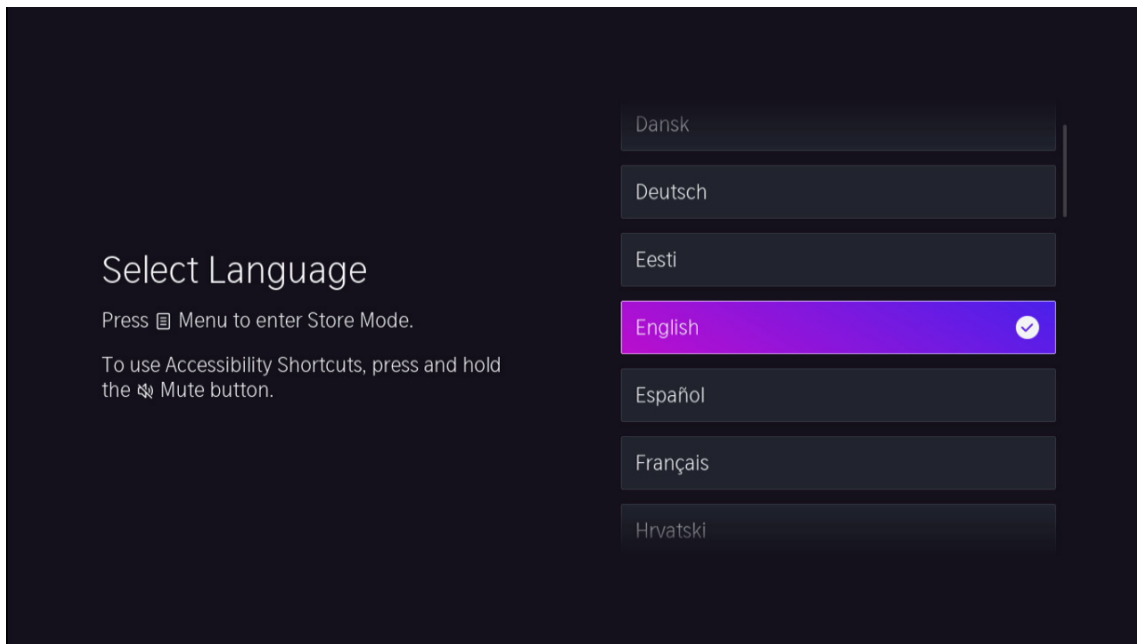

INITIAL SETUP (CONT.)

Use the ▲ / ▼ buttons to select location, then press **OK/SELECT** to confirm.

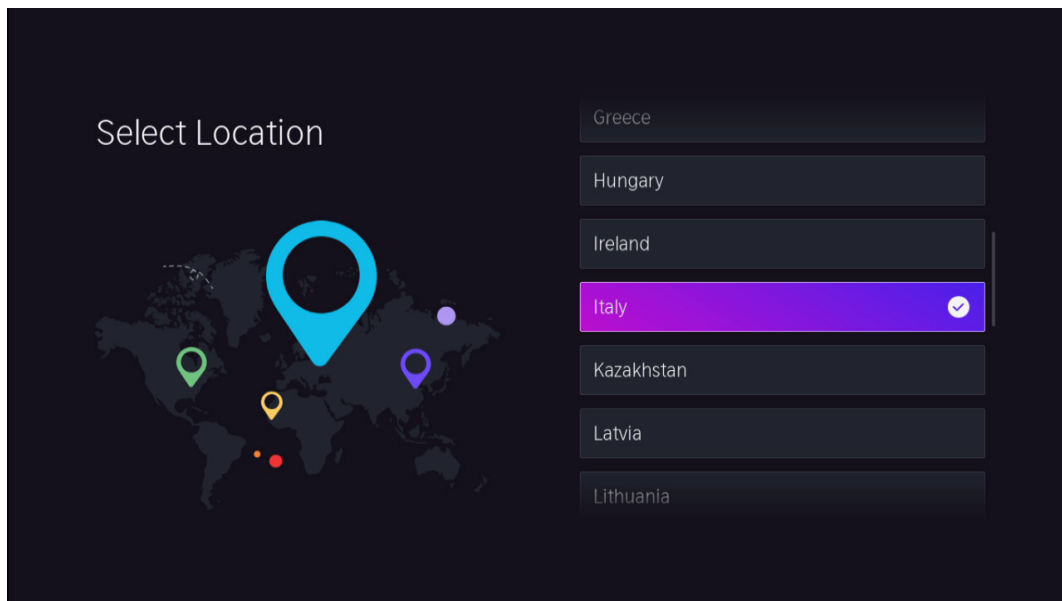

Use the ▲ / ▼ buttons to select channel scan, or skip to continue TV setup.

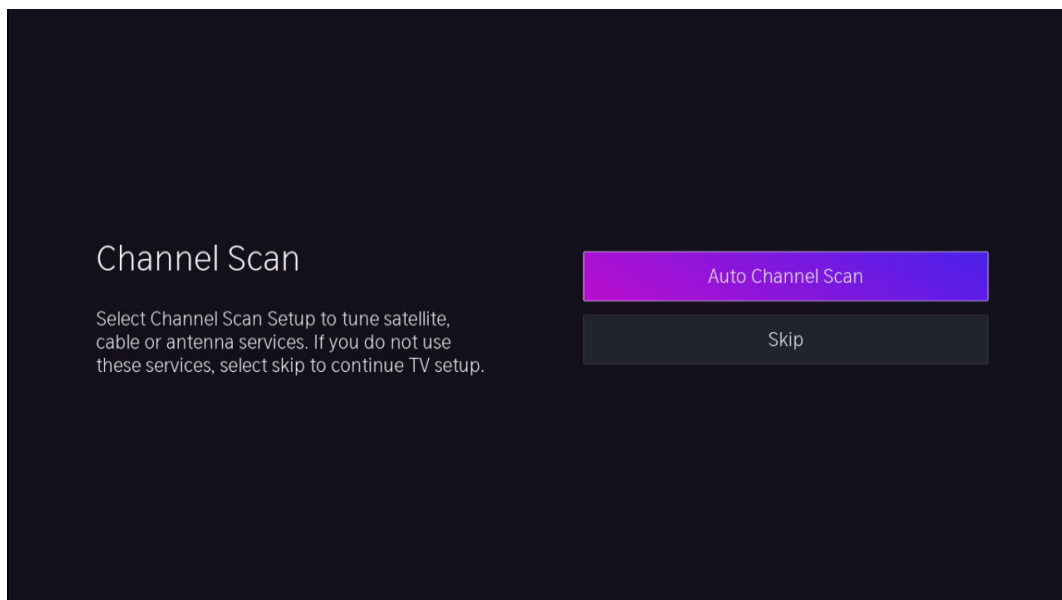

INITIAL SETUP (CONT.)

If select Auto Channel Scan, Create PIN will display as below, input 4 digits as password.

(Note: 0000 would be invalid.)

Press OK button to enter Channel Scan Setup.

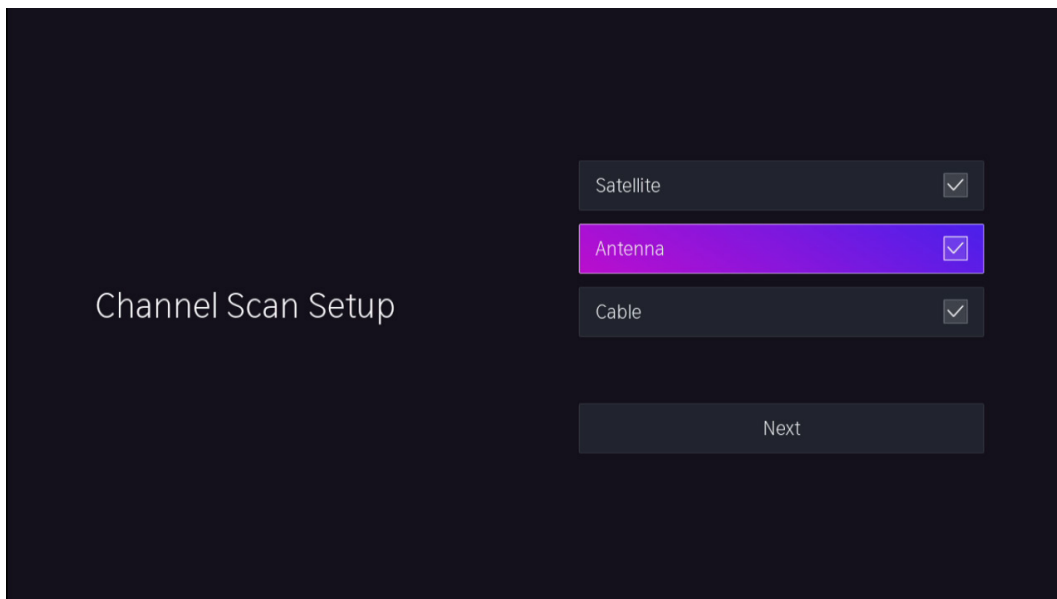
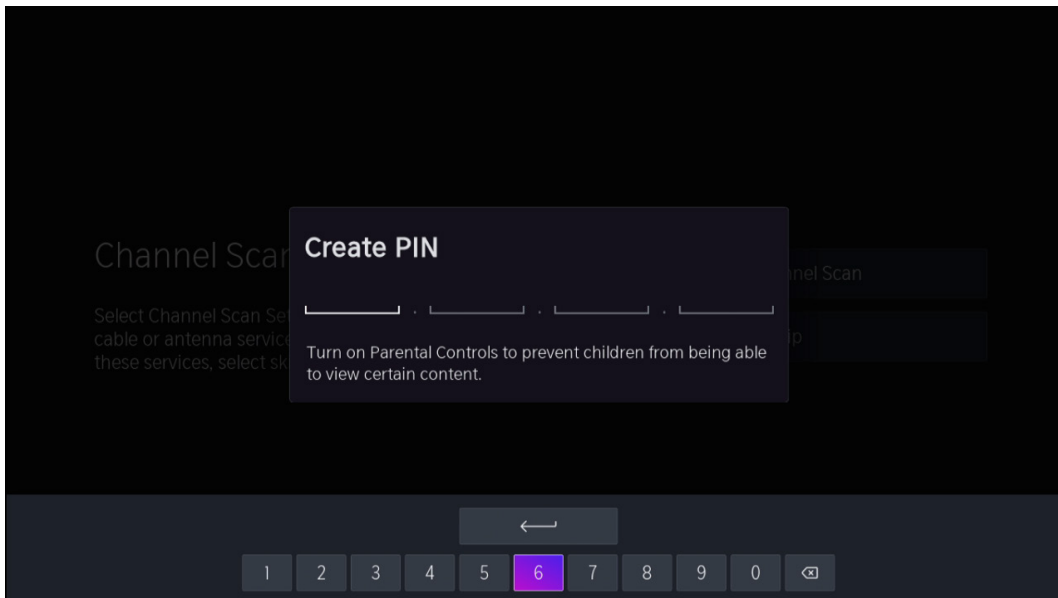

INITIAL SETUP (CONT.)

Press ▲ / ▼ to select your Wi-Fi you wish to connect to, enter the password and then confirm to connect.

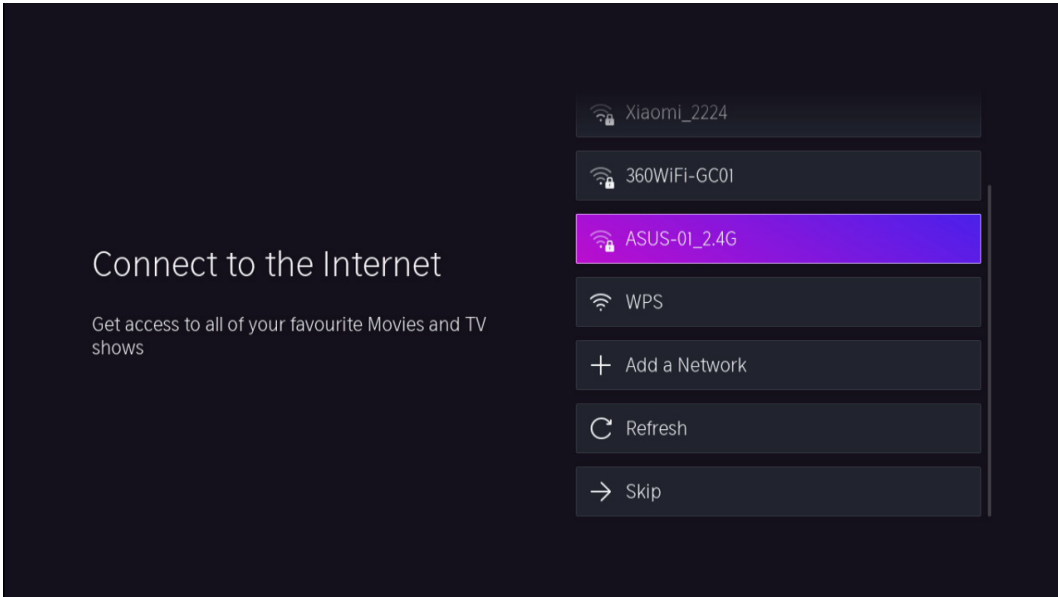

Press Up/Down button to highlight Select All, and press **OK** button to confirm the selection; then the cursor automatically jumps to OK & Go Next, and press OK to the next step.

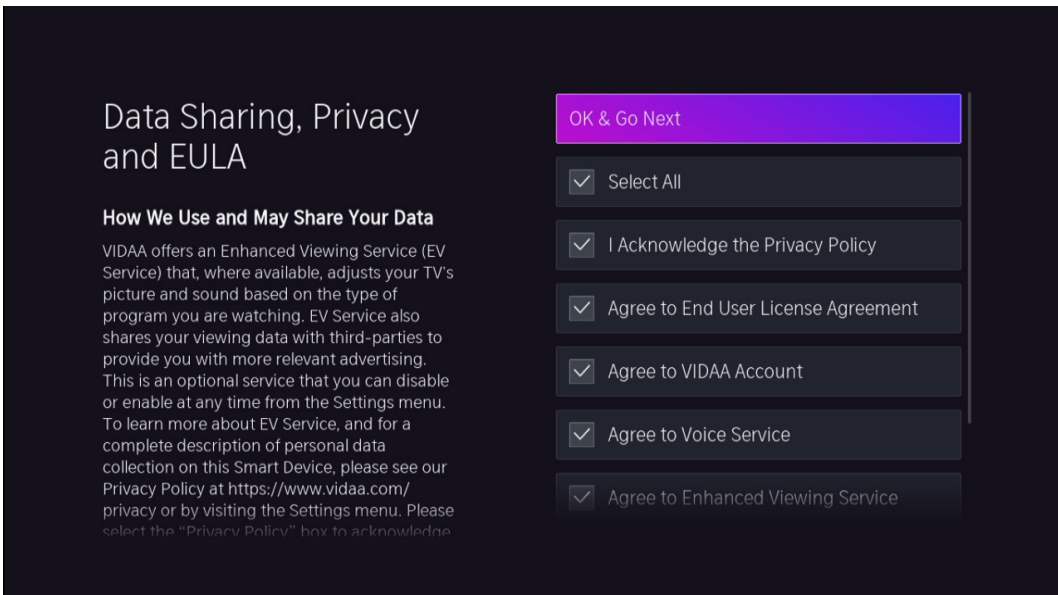

INITIAL SETUP (CONT.)

Create your VIDAA account: Create an account or skip to the next step.

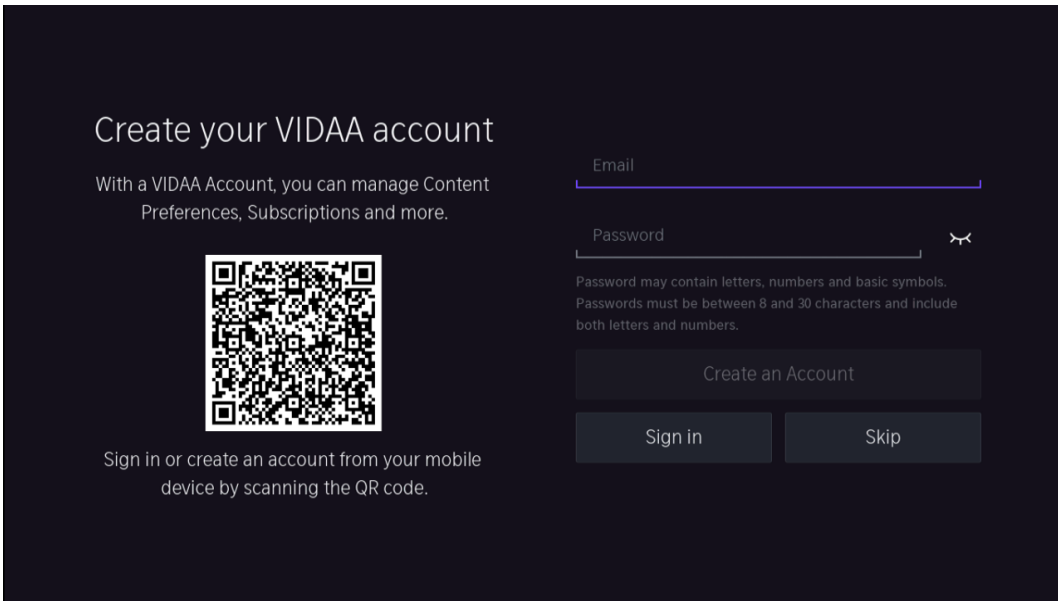

Press Up/Down button to select a unique name for your TV, to help identify it when casting or connecting to it from other devices; Press **OK** button to confirm.

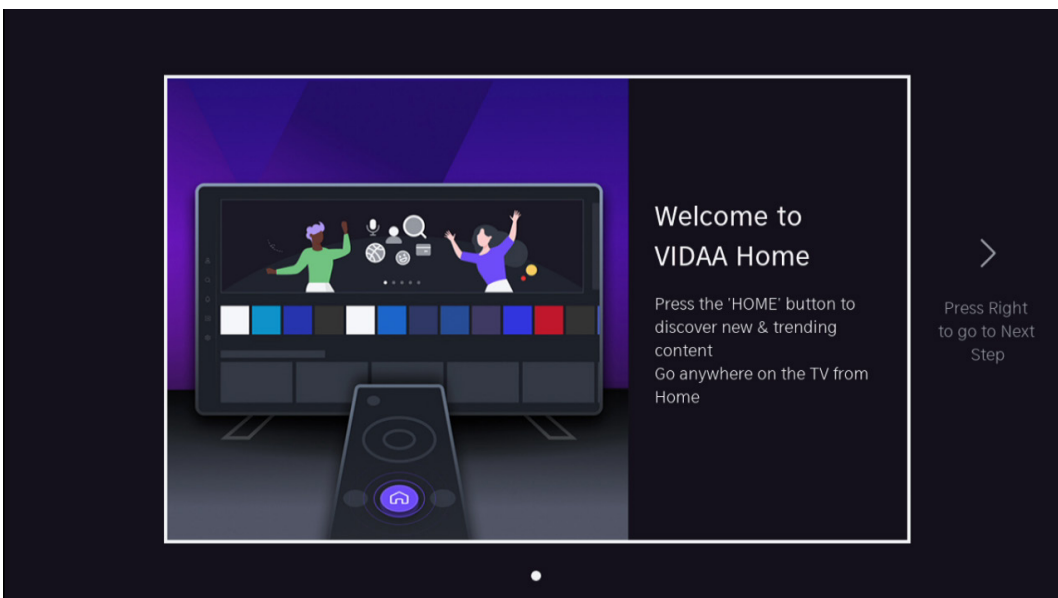
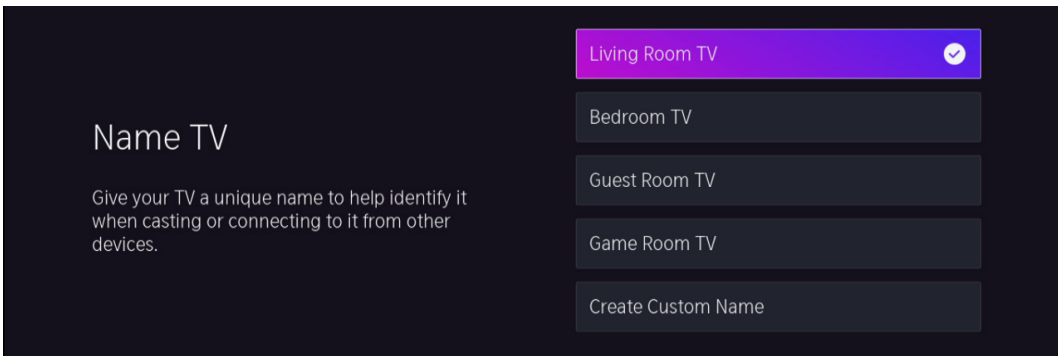

VIDAA TV - HOME SCREEN

Once you have completed initial setup, you will now enter the VIDAA TV home screen. Press  on remote control to enter Home Page.

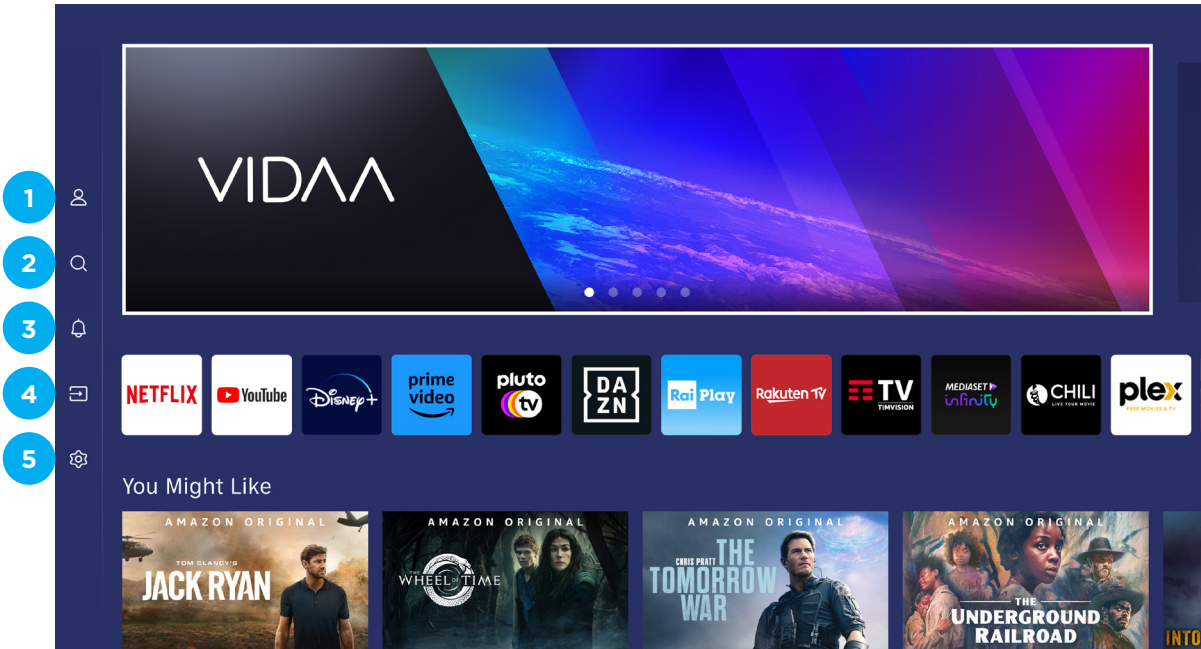

Manage apps: Select the item you want to move, and long press **OK** button to move or uninstall app.

1. **VIDAA account** - Sign in your VIDAA account.
A VIDAA account gives you all the best feature of your smart TV and always keeps it up to date
2. **Search** - Search the app you want.
3. **Notifications** - Allow pop-up notifications to appear for useful information and events that occur with your TV.
Select Notifications on the Home screen, and select Settings then display Advertising, New Arrivals, Warnings And Legal Statements, System Message, from which you can choose the types of notifications you would like to receive.
4. **Input** - Select the input source.
5. **SETTINGS** - Select this if you want to access TV settings.

SETTING - PICTURE

To access **SETTINGS** menu, select **SETTINGS (#5 on page 26)** via the HOME screen.

To access **Picture** menu, select **Setting (#5 on page 26)** menu and go down and select **Picture**.

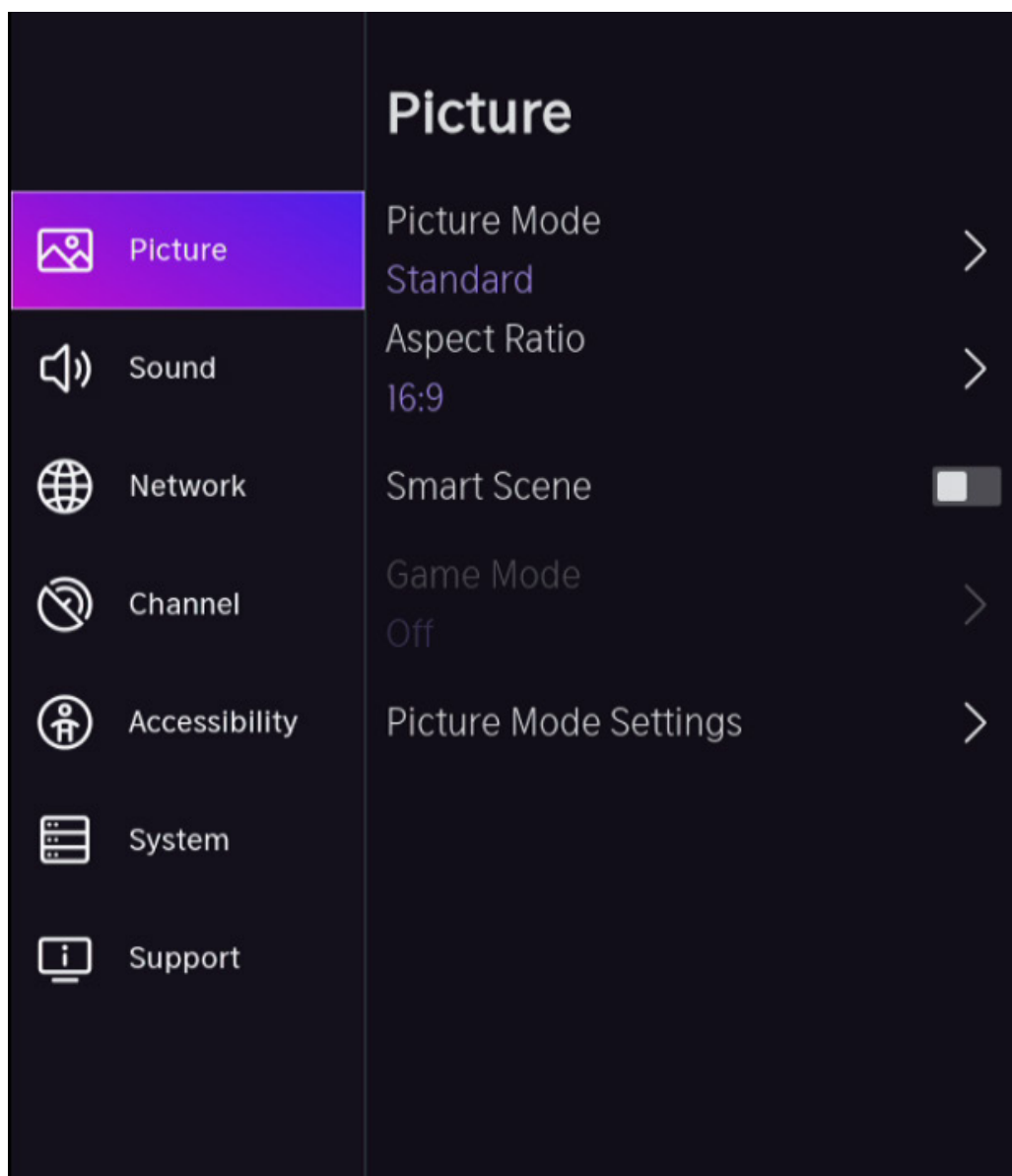

Picture Settings information on next page

SETTING - PICTURE

Picture Mode

You can select the Picture Mode that provides the best viewing experience.

- **Standard:** The default mode, to make users experience high-quality images under normal light.
- **Cinema Day:** Enhance the contrast, color and clarity of the screen to make the color more vivid.
- **Cinema Night:** Reduce the screen contrast, color and clarity to make the screen looks soft.
- **Dynamic:** Enhance the contrast, color and clarity of the screen, so that the picture in the dynamic will balance the color.
- **Sports:** This mode is more suitable for watching sport video.

Aspect Ratio

You can adjust the Aspect Ratio to stretch or zoom the picture.

Smart Scene

Recognise the current scene and enhance the picture quality.

- Auto, 16:9, 4:3, Movie Zoom

Game Mode

Choosing the Game Mode under ON/OFF

Optimised for PC or Games consoles. Reduces Input Lag and improves responsiveness.

Picture Mode Settings

Adjust display setting for each Picture Mode

- Apply Picture Settings: Adjust current picture mode to apply to all sources or just current source.
- Backlight: Adjust image backlight. (Optional: Off/Low/High).
- Brightness Adjust image brightness.
- Contrast: Adjust image contrast.
- Color Saturation: Adjust image color density.
- Sharpness: Adjust the image edge sharpness.
- Adaptive Contrast: Automatically adjust dark areas and light areas of the image to see more details. Press navigation button to select Off/Low/Medium/high.
- Noise Reduction: Improve the picture quality by reducing noise. (Optional: Off/Low/Medium/High).
- MPEG Noise Reduction: Reduces MPEG block noise to provide clearer edge transitions. (Optional: Off/Low/Medium/High).
- Colour Temperature: Adjust the overall color of the image. (Optional: Warm1/Warm2/Standard/Cool).
- Expert Settings: Adjust the colour space and Gamma to best suit the content you're viewing.
- Overscan: Change the video size setting to crop the edges of the displayed image.
- Reset Current Mode: Restore all the picture settings in the current picture mode to the factory default values.

SETTING - SOUND

To access **SOUND** menu, select **Setting (#5 on page 26)** menu and go down and select **SOUND**.

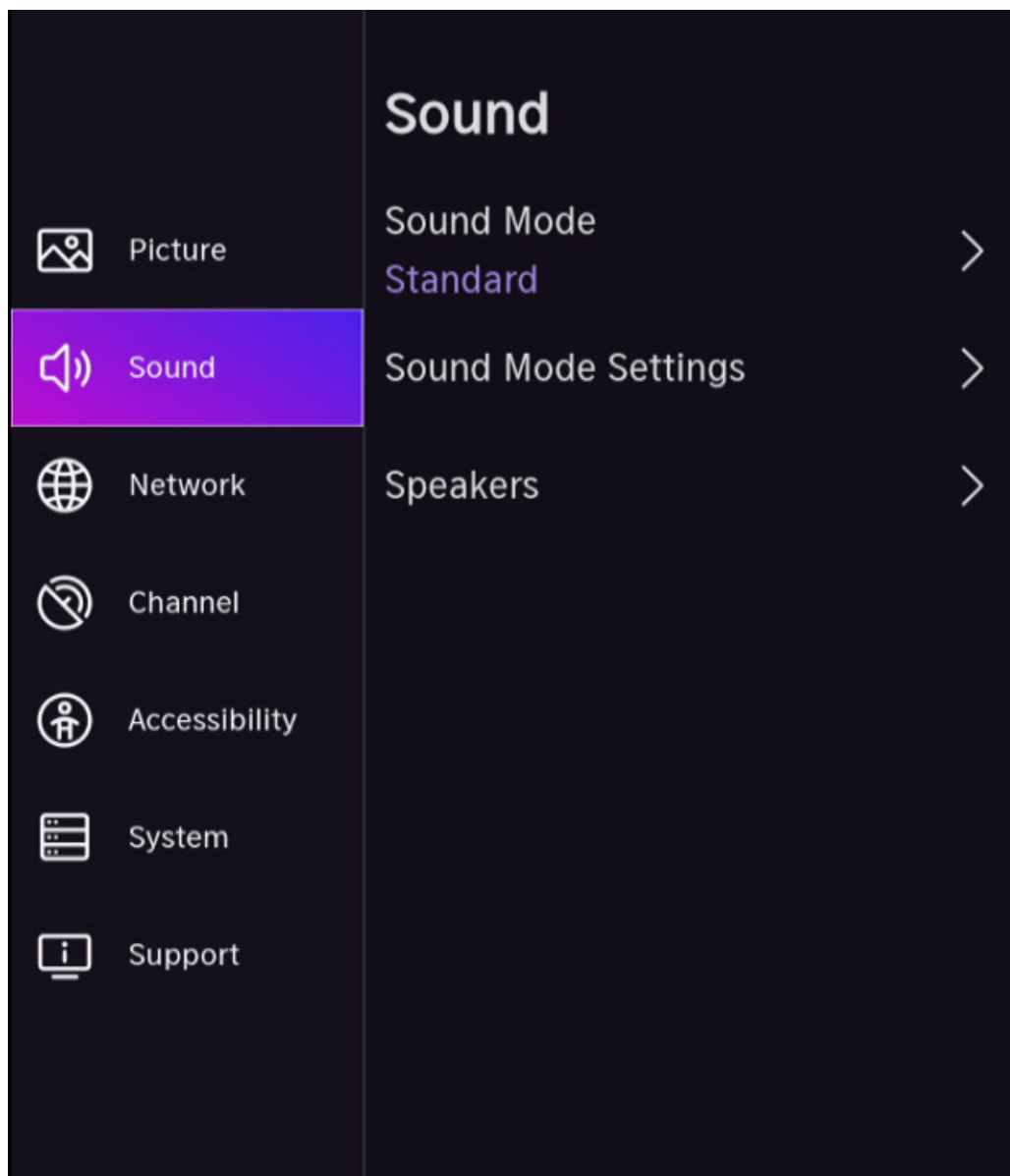

SOUND Settings information on next page

SETTING - SOUND

You can select a favorite sound mode suitable for the content type or the listening environment.

- **Standard:** Produced a balanced sound in all environment.
- **Theater:** Increased the surround sound effect and provides a more prominent bass response.
- **Music:** Preserves the original sound. Good for musical programs.
- **Speech:** Low and high frequencies are attenuated to improve the reproduction and clarity of the human voice.
- **Late Night:** Improve the reproduction and clarity of the human voice with a low volume level.
- **Sports:** Optimised sound for watching Sports events.

Audio Enhancement

Adjust the audio settings to improve the sound quality.

Sound Mode Settings

Adjust the audio settings of the TV: Apply Audio Settings/Equalizer/Wall Mount Setup/Auto Volume Control/Reset Current Mode.

Speakers

Select the speakers which you want to use.

SETTING - NETWORK

To access **NETWORK** menu, select **Setting (#5 on page 26)** menu and go down and select **NETWORK**.

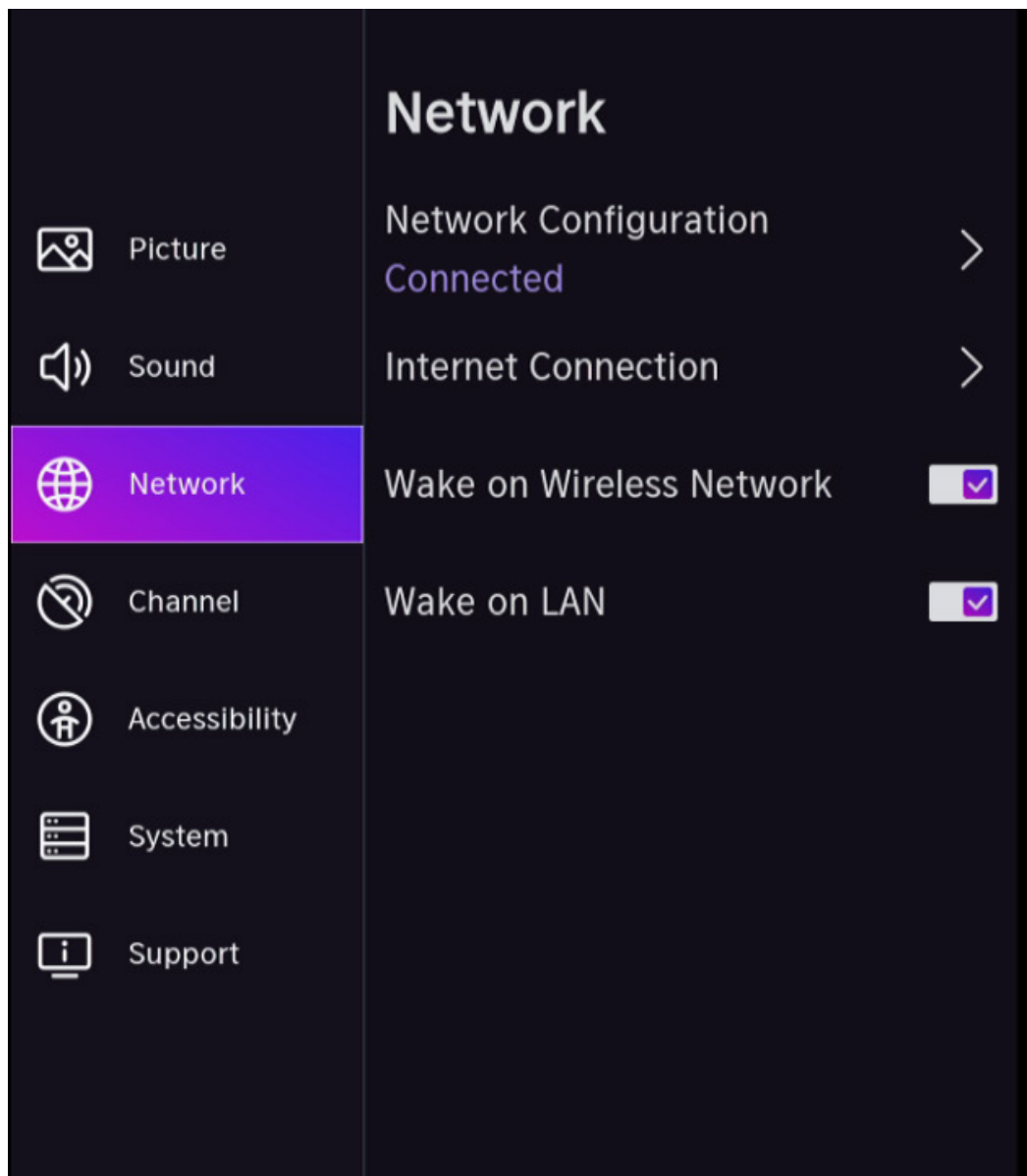

NETWORK Settings information on next page

SETTING - NETWORK

Network Configuration

You set the TV network by selecting Configuration and press the  button to enter the submenu.

Automatically obtain an IP address

1. If you connect to the wired network, the TV will automatically obtain an IP address and connect to the network.
2. If the connection fails, disconnected message will display for the Ethernet status. Retry or enter the IP settings, and select Manual to input the information again.

Manually enter the IP address

1. Enter the IP settings to select Manual.
2. Enter the IP Address, Netmask, Gateway, DNS Server 1 and DNS Server 2 in the menu.

Note:

- This section is only for 4K models.
- You get access to the Internet through your TV.
- The default option of IP Settings Mode is DHCP.

Wireless

Connecting to the Internet

Network Configuration

You set the TV network by selecting Configuration and press the  button to enter the submenu.

- Connection Type: Choose a wireless network connection to access the Internet.
- Refresh: Refresh wireless network.
- Advanced Settings: Configure the advanced wireless network settings for the TV.
- Add: You can add wireless network.

Note:

- If no wireless router is found, select Add and enter the network name in the SSID.
- If no wireless router is found, select Refresh.

Internet Connection

Check Internet connection.

Wake on Wireless Network

Using WLAN, turn on your TV with your TV with your mobile device.

Wake on LAN

Using Ethernet, turn on your TV with your TV with your mobile device.

Bluetooth

Connect to device using Bluetooth technology.

SETTING - CHANNEL

To access **CHANNEL** menu, select **Setting (#5 on page 26)** menu and go down and select **CHANNEL**.

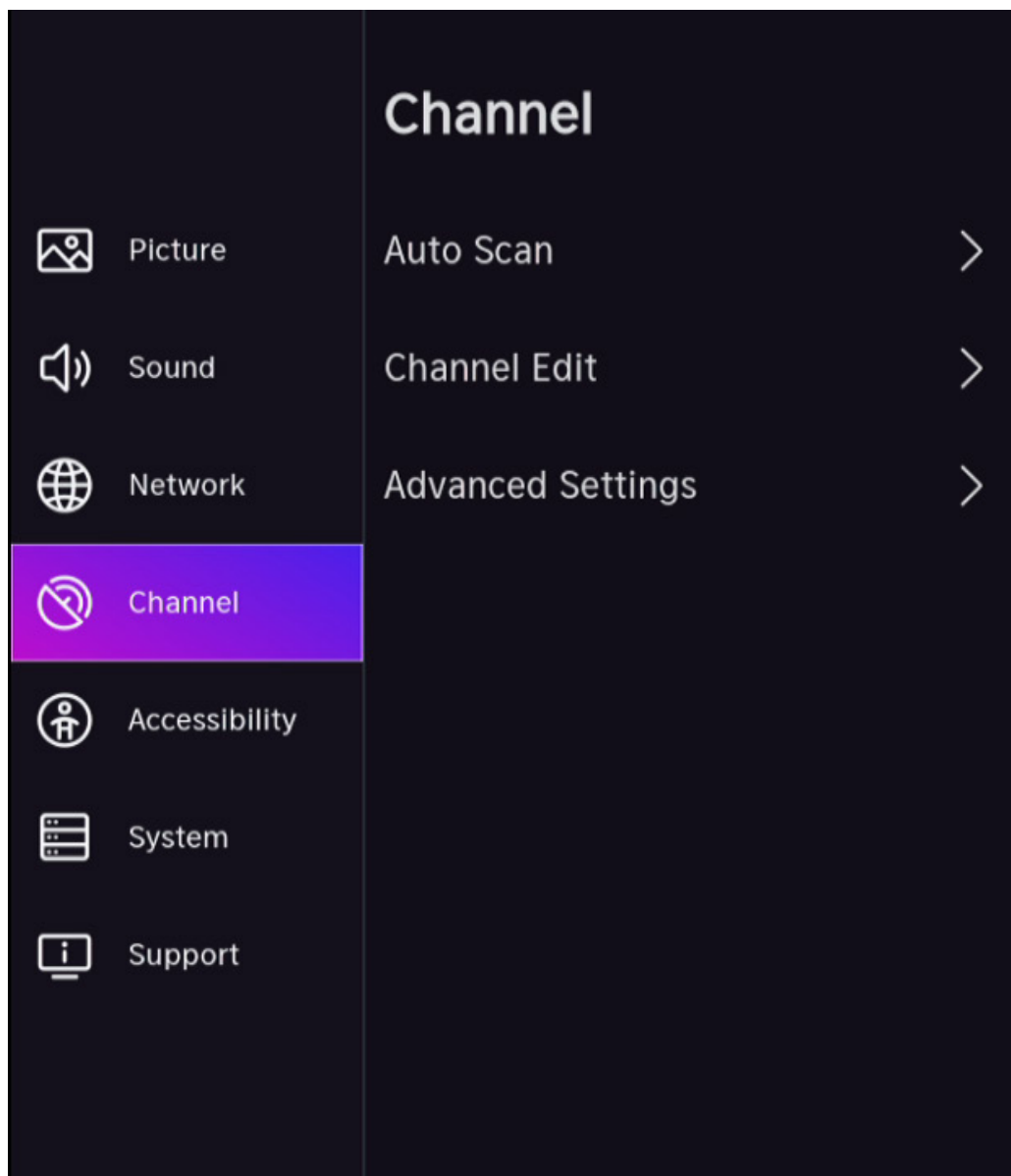

CHANNEL Settings information on next page

SETTING - CHANNEL

Auto Scan

Press **OK** button into the submenu, select Change Setup and press **OK** button to select Satellite, Antenna or Cable.

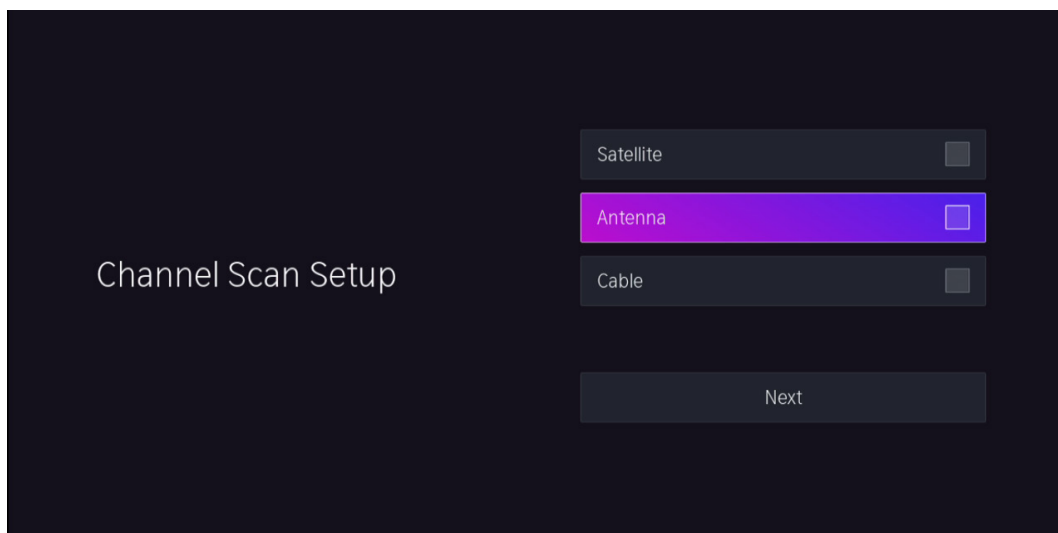

Channel List

- In Live TV, press to display the channel list.

Favorite

- Adding channels to your 'Favorites' list
- Press **OK** button to call out the channel list, the channel list appears on the right side of the screen.
- Press **≡** > **OK** to select your favorite channel.
- Press **←** and Choose Add to Favorite, a heart-shaped icon will appear next to your favorite channel.
- Press **OK** to call out the channel list, the channel list appears on the right side of the screen.
- Press **→** > Favorite > **→**, press the Navigation button select FAV1, FAV2, FAV3 or FAV4 press ok and your favorite channel with a heart-shaped icon will appear on the favorite list.

Deleting channels from your 'Favorite' list

- Press **OK** to call out the channel list, the channel list appears on the right side of the screen.
- Press **→** > Favorite, using the Navigation button to select **✎** (Edit) into the submenu, select the FAV channel that you want to delete.
- Press **→** to delete.

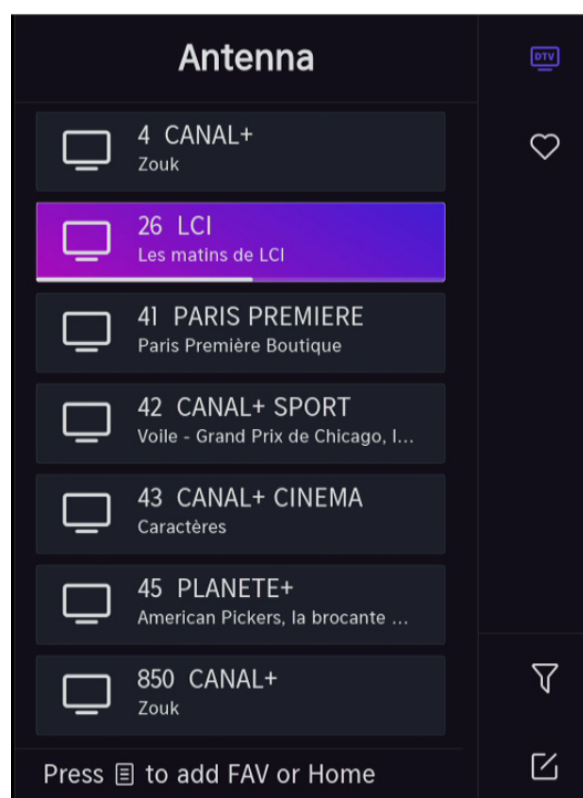

SETTING - CHANNEL

TV Guide

- In Live TV, display the TV Guide.
- Press **GUIDE** button on remote control, or press  > **Guide**, to call out the Guide

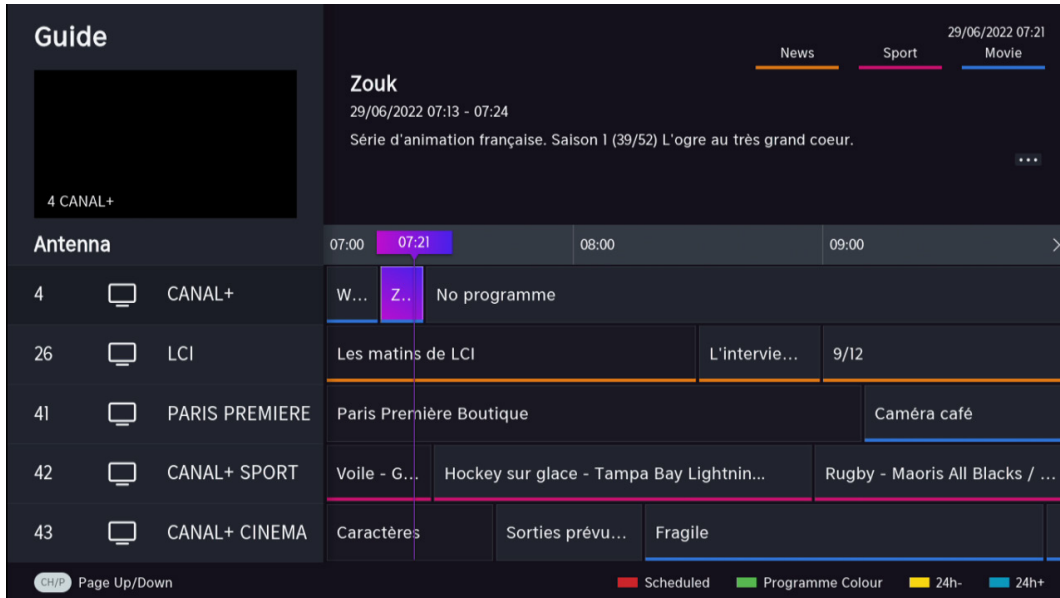

- Press **Up/Down** navigation button to select preferred channel.
- Press **Left/Right** navigation button to select preferred programme of some channel.
- Press the **RED** button to display a list of scheduled reminders.
- Press the **GREEN** button to display the colour menu and select GREEN, use the colors to indicate different genres in the GUIDE for quick and easy viewing.
- Press the **YELLOW** button to display the program guide of the previous day.
- Press the **BLUE** button to display the program guide of the following day.

Channel Edit

Manually edit the channel list to your preference.

Advance Settings

Advanced channel settings.

SETTING - ACCESSIBILITY

To access **ACCESSIBILITY** menu, select **Setting (#5 on page 26)** menu and go down and select **ACCESSIBILITY**.

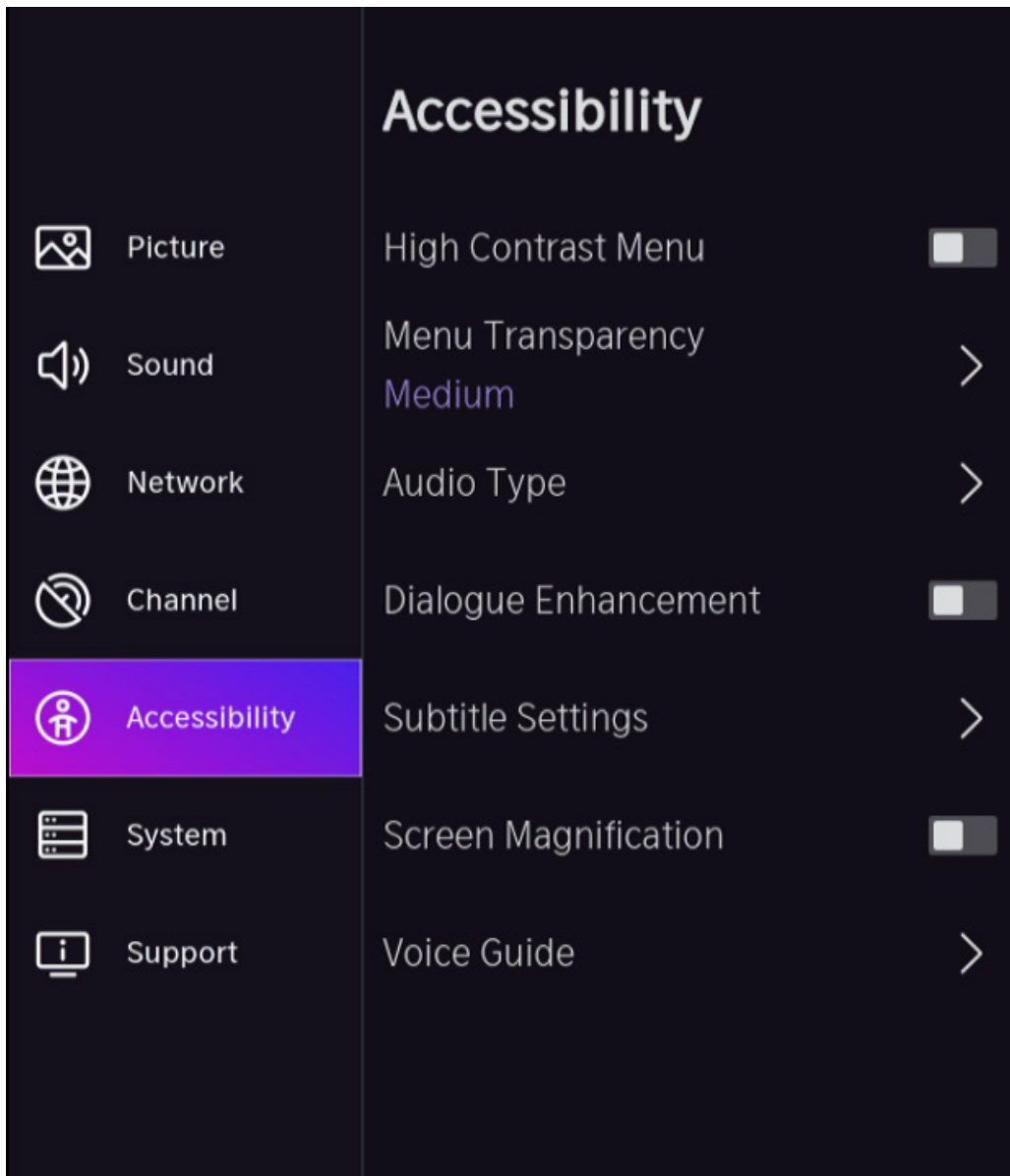

- **High Contrast Menu:** Turn High Contrast Menu On or Off.
- **Menu Transparency:** Set the transparency of menu. (Optional: Off/Medium/High)
- **Audio Type:** Accessibility audio settings.
- **Dialogue Enhancement:** Enable or disable dialogue enhancement.
- **Subtitle Settings:** Adjust Subtitle Settings for digital broadcast content.
- **Screen Magnification:** Allow visually impaired/partially sighted viewers to magnify an area of the screen.
- **Voice Guide:** Voice Guide setup.

SETTING - SYSTEM

To access **SYSTEM** menu, select **Setting (#5 on page 26)** menu and go down and select **SYSTEM**.

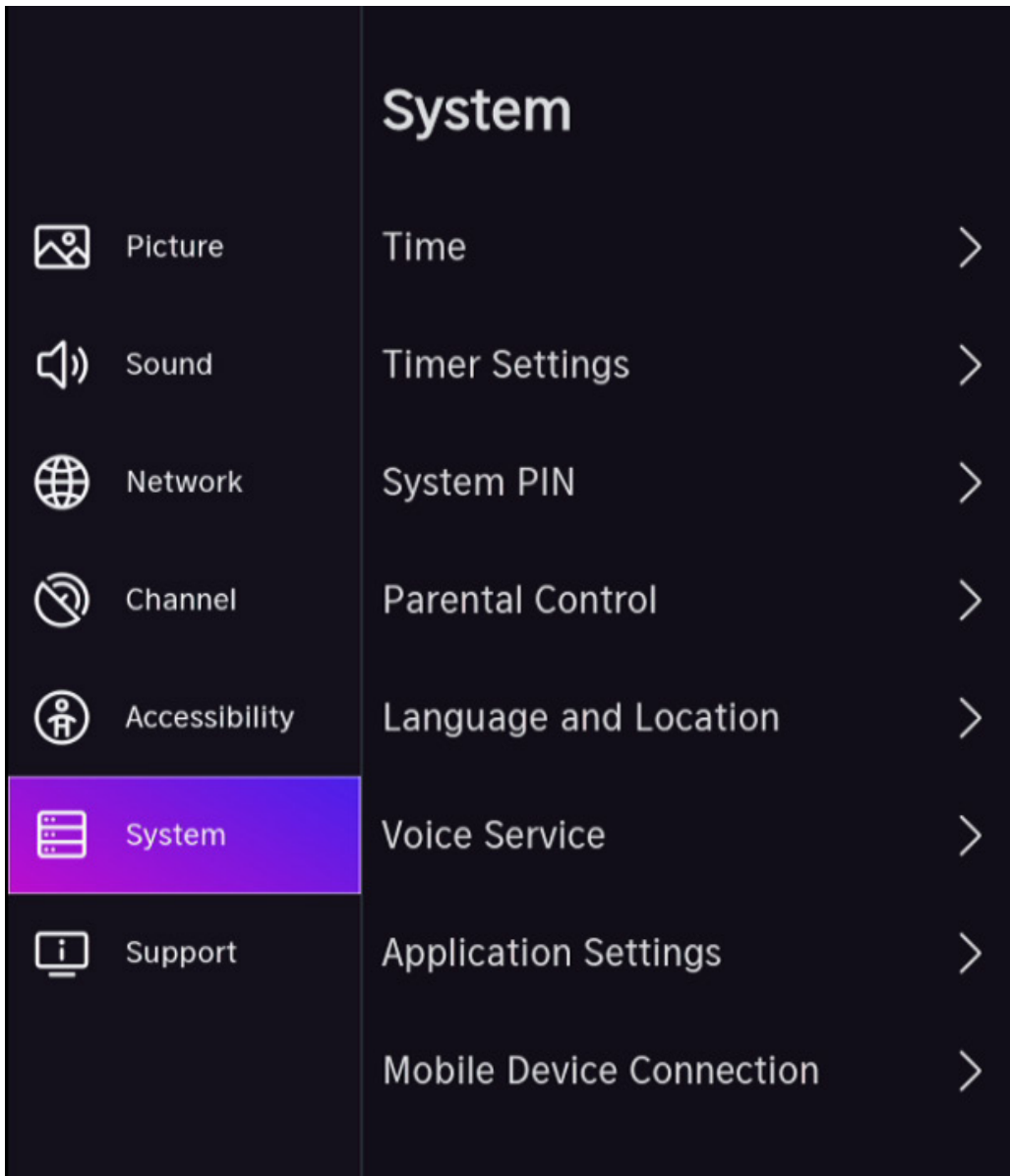

SYSTEM Settings information on next page

SETTING - SYSTEM

Time:

Set the current time based on your location.

- **Time Format:** Set the time to display in a 12 or 24-hour format.
- **Date/Time:** Set the date and time.
- **Time Zone:** Set the time zone.
- **Daylight Savings:** Select whether to apply Daylight Savings Time to the TV.

Timer Settings

Adjust the timer settings to suit your preference.

- **Sleep Timer:** Set the sleep timer to automatically turn the TV Off within a specified time: Off, 15 Minutes, 30 Minutes, 60 Minutes, 90 Minutes, 120 Minutes, User Defined.
- **Power On Timer:** Set the clock for the time you want the TV to turn on automatically. You can set the time only once or set the time in specified date weekly.
- **Power Off Timer:** Set the clock for the time you want the TV to turn off automatically. You can set the time only once or set the time in specified date weekly.
- **Menu Timeout:** Set the amount of time that you would like for the menu to display: Off, 10s, 20s, 30s, 60s.
- **Auto Sleep:** Set the amount of time that you would like the TV to auto power off after a period of no activity : Off, 3H, 4H.
- **Auto Standby with No Signal:** TV will go to standby if there is no signal after the set time: Off, 15min.

System PIN

Change the PIN that you use to access Parental Control, Auto Channel Scan and Reset to Factory Default.

Parental Control

Turn on Parental Controls to prevent children from being able to view certain content.

Language and Location

Choose the language of the TV and your location.

Voice Service

Use your voice to control the TV, other smart home devices and more.

Application Settings

Set up Application preferences.

Mobile Device Connection

Connection management of a mobile device, smartphone, or personal computer.

SETTING - SYSTEM

HDMI & CEC

You can use your TV remote to control the external devices that are connected to the TV by HDMI cable. The external devices need to support HDMI & CEC Function (HDMI-CEC).

1. Set HDMI Control to On.
2. Connect an HDMI-CEC-compliant device to the TV.
3. Turn on the connected external device. The device is automatically connected to the TV.
4. After connection is finished, you can access the menu of the connected device on your TV screen using your TV remote and control the device.

Note:

- HDMI cables must be used to connect HDMI CEC-compatible devices to your TV.
- The HDMI CEC feature of the connected device must be turned on.
- If you connect an HDMI device that is not HDMI CEC-compatible, all the HDMI-CEC control features do not work.
- Depending on the connected HDMI device, the HDMI-CEC Control feature may not work.

SETTING - SUPPORT

To access **SUPPORT** menu, select **Setting (#5 on page 26)** menu and go down and select **SUPPORT**.

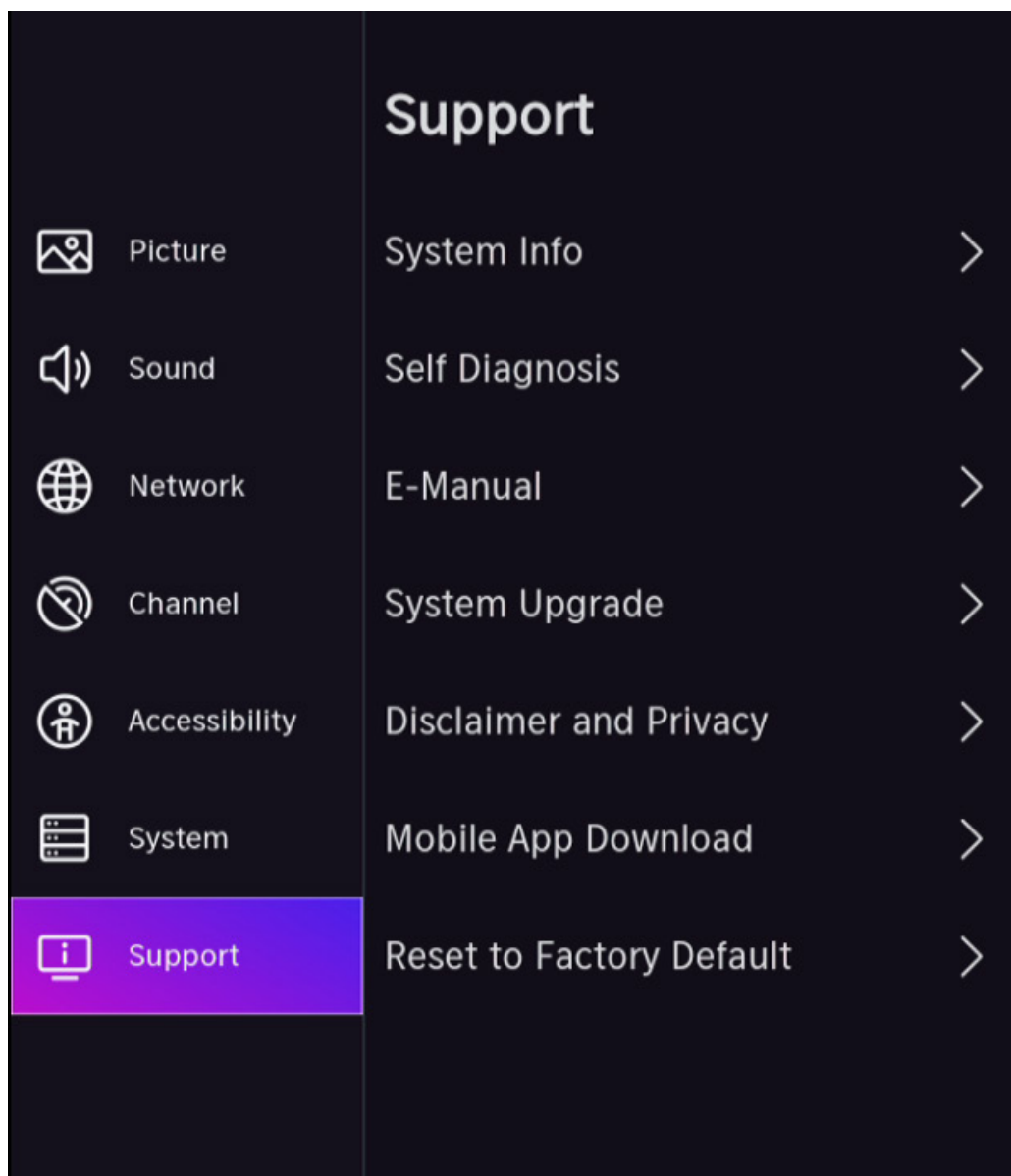

SYSTEM Settings information on next page

SETTING - SUPPORT

System Info

View System information.

Self Diagnosis

Perform self diagnosis to test sound, picture and connections.

E-Manual

Launch the E-Manual and get to know more about your TV: First-Time Use, Enjoy Live TV, Benefits of Smart TV, Connecting to External Devices, Settings Overview, Entertainment, Accessibility Features, Troubleshooting.

System Upgrade

Set your TV to receive the latest firmware.

- **Auto Firmware Upgrade:** Set your TV to automatically receive the latest firmware.
- **Check Firmware Upgrade:** Check to ensure that your TV has received the latest firmware.
- **System App Auto Upgrade:** App auto upgrade will be done in the background. May need your confirmation on new Privacy Notices to complete upgrade in the progress.
- **Upgrade From USB:** Upgrade TV software from USB device.

Note:

- Please ensure the USB flash drive insert to USB2.0 port of the TV.
- The updating files must be available in root directory.
- The format of the USB must be FAT32 and the partition table type must be MBR.

Disclaimer and Privacy

Click to read the Disclaimer details.

Mobile App Download

Install mobile app on your smartphone to control your TV. This app is available on both Android and iOS.

Reset to Factory Default

Restore your TV to the factory default.

MULTI-SCREEN

Screen Sharing

Mirror content from your device to the TV.

Press **INPUT** enter Screen Sharing.

1. Turn on the casting function of your Android/Windows10 device.
2. Find the TV name in the searching list of your device and select it. Wait for the connection progress to complete and the content on your device will be displayed on the TV.

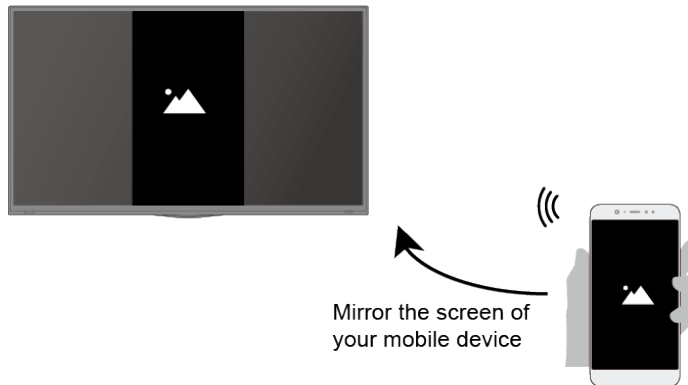

NOTE: some Android devices may not support casting.

Content Sharing

Share media content, like videos, music or photos, from your device to the TV screen.

Before you use this function, turn on Content Sharing at **Settings > System > Mobile Device Connection > Content Sharing.**

- Establishing Content Sharing connection between the TV and your device
 1. Turn on the content sharing function of your device.
 2. Find the TV name in the searching list of your device and select it.
 3. Wait for the connection progress to complete, and select the content you want to share.

- Viewing media content of your device

Press **INPUT** button on your remote, and select a media content on the screen.

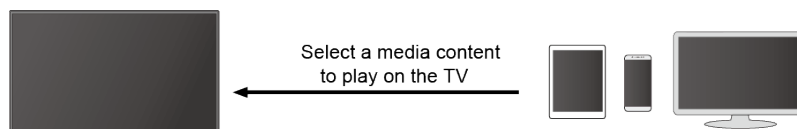

Note:

- Make sure your device and the TV are connected to the same network.
- Some devices may not support content sharing. If your device doesn't support content sharing, you can download an app that supports the function.
- If you want to mirror content from your device, go to **INPUT > Screen Sharing.**

USB DEVICE

Connect the USB devices such as hard drives, USB sticks and digital cameras for browsing photos, listening to music.

Media

Playing Media contents

> Media

By default, there are Content Sharing displayed on the Media screen. If your mobile device is connected to the TV, its name also appears on the Media screen.

Note: For more information about Content Sharing, refer to its detailed introduction.

> Media > connected device

Select the content you want to play on the screen, like pictures, videos and music.



1. Input the content name you want to play.
2. Arrange the content list by Grid, List.
3. Arrange the content list by Name, Date Modified, Size.
4. Filter the content list by All Media, Photo, Video, Music.
5. Create a photo, music, or video playlist.

FAQs

GENERAL PROBLEMS WITH TV SET

Symptoms	Items to check and actions to follow
"ghost" or double image	This may be caused by obstruction to antenna due to high rise buildings or hills. Using a highly directional antenna may improve the picture.
No power	<ul style="list-style-type: none"> • Check if the TV's AC power cord is plugged into the outlet. • Unplug the TV, wait for 60 seconds. Then reinsert plug into the outlet and turn on the TV again.
No picture	<ul style="list-style-type: none"> • Check antenna connections at the rear of the TV to see if it is properly connected to the TV. • Possible broadcast station trouble. Try another channel. • Adjust the contrast and brightness setting. • Check the Closed Captions control. Some TEXT modes could block the screen.
Good picture but no sound	<ul style="list-style-type: none"> • Increase the volume level by pressing the VOL+ button on the remote control or on the TV side control panel. • Press the MUTE button on the remote control to ensure mute is off.
Good sound but poor color	Adjust the contrast, color and brightness settings
Snowy picture and noise	Check the antenna connection
Horizontal dotted line	This may be caused by electrical interference (e.g. hair dryer, near-by neon lights, etc.) Turn off the equipment.
Television not responding to remote control	<ul style="list-style-type: none"> • Check whether the batteries are working. Replace if necessary. • Clean the remote control sensor lens on the TV. • You can still use the buttons on the side of your TV.
Pixels (dots) that are always dark or always lit	Your TV is precision-manufactured using an extremely high level of technology. However, sometimes pixels may not display correctly. These types of occurrences are inherent to this type of product and do not constitute a defective product.

Italiano



Trattamento del dispositivo elettrico od elettronico a fine vita (Applicabile in tutti i paesi dell'Unione Europea e in quelli con sistema di raccolta differenziata)

Il simbolo del cassonetto barrato riportato sull'apparecchiatura indica che il prodotto alla fine della propria vita utile deve essere raccolto separatamente dagli altri rifiuti. L'utente dovrà pertanto conferire l'apparecchiatura integra dei componenti essenziali giunta a fine vita agli idonei centri di raccolta differenziata dei rifiuti elettronici ed elettrotecnici, oppure riconsegnarla al rivenditore al momento dell'acquisto di nuova apparecchiatura di tipo equivalente, in ragione di uno a uno, oppure 1 a zero per le apparecchiature aventi lato maggiore inferiore a 25cm.

Assicurandovi che questo prodotto sia smaltito correttamente, voi contribuirete a prevenire potenziali conseguenze negative per l'ambiente e per la salute che potrebbero altrimenti essere causate dal suo smaltimento inadeguato. Il riciclaggio dei materiali aiuta a conservare le risorse naturali. Per informazioni più dettagliate circa il riciclaggio di questo prodotto, potete contattare l'ufficio comunale, il servizio locale di smaltimento rifiuti oppure il negozio dove l'avete acquistato.

Chiunque abbandona o cestina questo apparecchio e non lo riporta in un centro di raccolta differenziata per rifiuti elettrici-elettronici è punito con la sanzione amministrativa pecuniaria prevista dalla normativa vigente in materia di smaltimento abusivo di rifiuti di cui al D.Lgs n. Decreto Legislativo N°49 del 14 Marzo 2014.

English



Disposal of old electrical & electronic equipment (Applicable in the European Union and other European countries with separate collection systems)

This symbol on the product or in its packaging indicates that this product shall not be treated as household waste. Instead it shall be handed over to the applicable collection point for the recycling of electrical and electronic equipment. By ensuring this product is disposed of correctly, you will help prevent potential negative consequences for the environment and human health, which could otherwise be caused by inappropriate waste handling of this product. The recycling of materials will help to conserve natural resources. For more detailed information about recycling of this product, please contact your local city office, your household waste disposal service or the shop where you purchased the product.

Français



Traitement des appareils électriques et électroniques en fin de vie (Applicable dans les pays de l'Union Européenne et aux autres pays européens disposant de systèmes de collecte sélective)

Ce symbole, apposé sur le produit ou sur son emballage, indique que ce produit ne doit pas être traité avec les déchets ménagers. Il doit être remis à un point de collecte approprié pour le recyclage des équipements électriques et électroniques. En s'assurant que ce produit est bien mis au rebus de manière appropriée, vous aiderez à prévenir les conséquences négatives potentielles pour l'environnement et la santé humaine. Le recyclage des matériaux aidera à conserver les ressources naturelles. Pour toute information supplémentaire au sujet du recyclage de ce produit, vous pouvez contacter votre municipalité, votre déchetterie ou le magasin où vous avez acheté le produit.

Español



Tratamiento de los equipos eléctricos y electrónicos al final de su vida útil (Aplicable en la Unión Europea y en países europeos con sistemas de recogida selectiva de residuos)

Este símbolo en su equipo o su embalaje indica que el presente producto no puede ser tratado como residuos domésticos normales, sino que deben entregarse en el correspondiente punto de recogida de equipos eléctricos y electrónicos. Asegurándose de que este producto es desechado correctamente, Ud. Está ayudando a prevenir las consecuencias negativas para el medio ambiente y la salud humana que podrían derivarse de la incorrecta manipulación de este producto. El reciclaje de materiales ayuda a conservar las reservas naturales. Para recibir información detallada sobre el reciclaje de este producto, por favor, contacte con su ayuntamiento, su punto de recogida más cercano o el distribuidor donde adquirió el producto.

Deutsch



Entsorgung von gebrauchten elektrischen und elektronischen Geräten (Anzuwenden in den Ländern der Europäischen Union und anderen europäischen Ländern mit einem separaten Sammelsystem für diese Geräte)

Das Symbol auf dem Produkt oder seiner Verpackung weist darauf hin, dass dieses Produkt nicht als normaler Haushaltsabfall zu behandeln ist, sondern an einer Annahmestelle für das Recycling von elektrischen und elektronischen Geräten abgegeben werden muss. Durch Ihren Beitrag zum korrekten Entsorgen dieses Produkts schützen Sie die Umwelt und die Gesundheit Ihrer Mitmenschen. Umwelt und Gesundheit werden durch falsches Entsorgen gefährdet. Materialrecycling hilft den Verbrauch von Rohstoffen zu verringern. Weitere Informationen über das Recycling dieses Produkts erhalten Sie von Ihrer Gemeinde, den Kommunalen Entsorgungsbetrieben oder dem Geschäft, in dem Sie das Produkt gekauft haben.

Ayonz Central Ltd
83 Mount Eagle Drive,
Leopardstown Heights,
Sandyford, D18 E5N6, Ireland.
Prodotto in Cina



The logo for EKO is rendered in a clean, white, sans-serif typeface. The letter 'E' is composed of three horizontal bars. The 'K' is formed by a vertical stem and two diagonal strokes. The 'O' is a simple, rounded circle. The entire logo is centered horizontally in the upper half of the frame.

EKO

DISTRIBUTED BY:
Ayonz Central Ltd